

# アルポック A型 (公差 $\begin{matrix} +0 \\ -0.1 \end{matrix}$ )

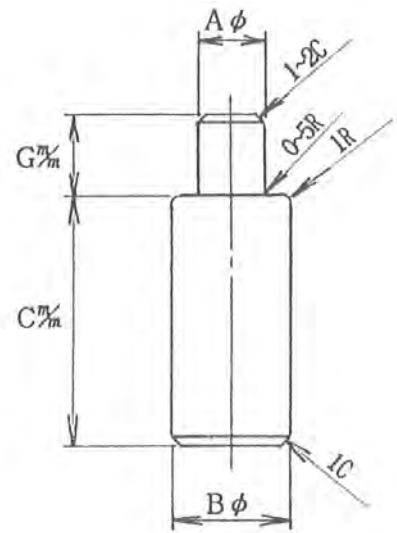

① 無印



② △印

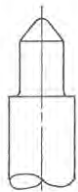

③ ※印

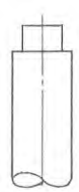

④ ×印

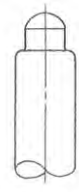

⑤ ×-I 印

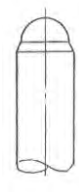

⑥ □印

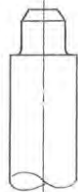

⑦ □-I 印

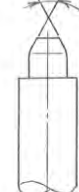

⑧ ▽-I 印



⑨ □-II 印

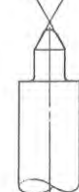

A 型	ΦA	ΦB	Cmm	Gmm